

High Speed, Rail-to-Rail 1.5A Dual Low Side Driver

FEATURES

- Two Independent Gate Drivers
- Rail-to-Rail Output
- Logic-Input Protection to -5V
- 1.5A Peak Output Current
- Wide Operating Range: 5V to 18V
- Input Voltages up to V_{CC}
- Compatible with 3.3V and 5V Logic Input
- Short Delay Time: 45ns at $V_{CC} = 15V$
- Output Rise and Fall Time of 10ns with 1000pF Load at $V_{CC} = 15V$
- Low Supply Current: 70 μ A at $V_{CC} = 15V$
- Leadfree, RoHS Compliant

PRODUCT DESCRIPTION

The TS6348 is a dual channel, high speed power MOSFET and IGBT driver, which are designed for applications that require low current signals to drive large capacitive loads with high speed. The input current is very low so that it is compatible with standard CMOS or LSTTL output. The output drivers feature a high pulse current buffer stage designed for minimum rise and fall time. Excellent latch immune performance is obtained.

APPLICATIONS

- Switching Mode Power Supplies
- Motor Drivers
- General Purpose Dual Low Side Drivers

BLOCK DIAGRAM

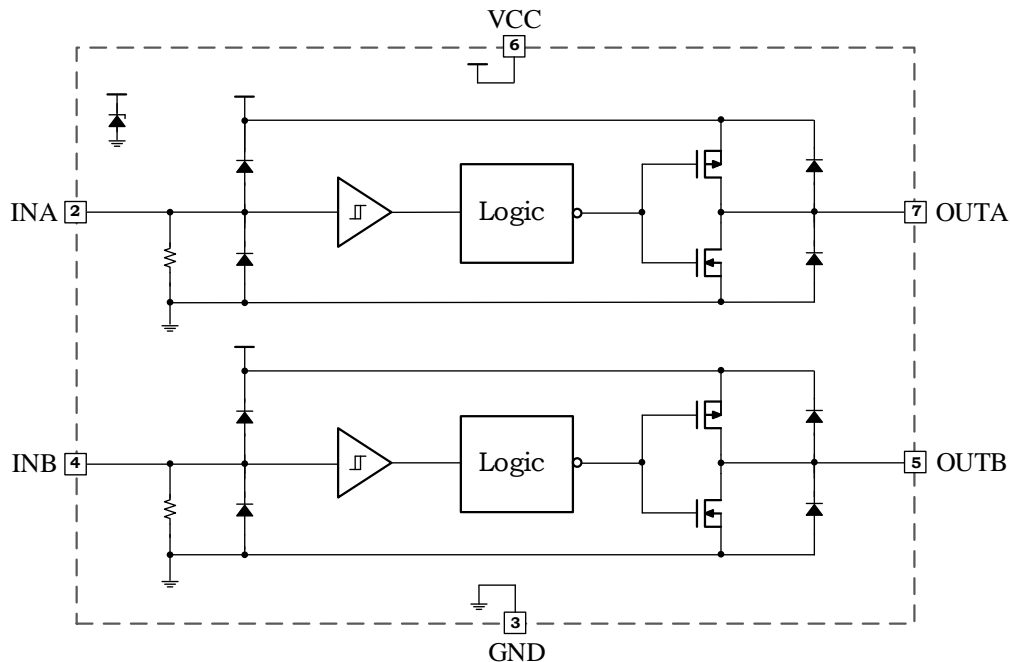

ORDERING INFORMATION

Product	Part Number	Eco Plan	MSL	Package	Container, Pack Qty
TS6348	TS6348SOP8R	RoHS	MSL1	SOP8	Reel, 2500

RECOMMENDED OPERATING CONDITIONS

Parameter	Min	Max	Unit
V _{CC} to GND Voltage	5	20	V
Input Voltage	0	V _{CC}	V
Operating Temperature	-40	125	°C

ABSOLUTE MAXIMUM RATINGS

Over operating free-air temperature range (unless otherwise noted) ⁽¹⁾

Parameter	Min	Max	Unit
V _{CC} to GND	-0.3	22 ⁽²⁾	V
Input Voltage	-5	V _{CC} + 0.3	V
Output Voltage	-0.3	V _{CC} + 0.3	V
Package Power Dissipation @ T _A ≤ 50°C ⁽³⁾	--	500	mW
Thermal Resistance, Junction to Ambient	--	200	°C/W
Junction Temperature	-40	150	°C
Storage Temperature	-55	150	°C
Lead Temperature (Soldering, 10s)	--	300	°C
Operating Temperature	-40	125	°C
ESD HBM	±4kV Class 3A (MIL-STD-883J Method 3015.9)		
ESD MM	±400V Class 3 (JEDEC EIA/JESD22-A115)		
ESD CDM	±1500V Class C3 (JEDEC EIA/JESD22-C101F)		
IC Latch-Up Test at Room Temperature	600mA @25°C Class I, Level A (JEDEC STANDARD NO.78E)		
IC Latch-Up Test at 125°C	400mA @125°C Class II, Level A (JEDEC STANDARD NO.78E)		

(1) Stresses beyond those listed under “Absolute Maximum Ratings” may cause permanent damage to the device. This is a stress rating only and functional operation of the device at these or any other conditions beyond those indicated in the operational sections of this specification is not implied. Exposure to absolute maximum rating conditions for extended periods may affect device reliability.

(2) The limit value of the working voltage is the power supply voltage value at room temperature, when the chip is in static working condition and the chip reaches the maximum working time.

(3) The Package Power Dissipation is related to T_{J (max)}, θ_{JA} and T_A. The maximum allowable power dissipation at any allowable ambient temperature is PD = (T_{J (max)} – T_A) / θ_{JA}.

ESD CAUTION



ESD (Electrostatic Discharge) sensitive device. Charged devices and circuit boards can discharge without detection. Although this product features patented or proprietary protection circuitry, damage may occur on devices subjects to high energy ESD. Therefore, proper ESD precautions should be taken to avoid performance degradation or loss of functionality.

PIN CONFIGURATION

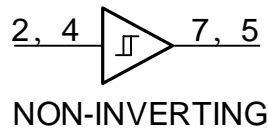
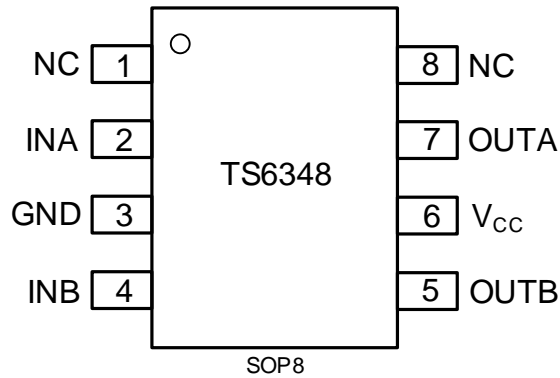

PIN DEFINITIONS

Pin No	Symbol	Function
1	NC	No Connection
2	INA	Logic Input of Channel A
3	GND	Ground
4	INB	Logic Input of Channel B
5	OUTB	Output of Channel B
6	V _{cc}	Power Supply
7	OUTA	Output of Channel A
8	NC	No Connection

ELECTRICAL CHARACTERISTICS

At $T_A = +25^\circ\text{C}$, and $V_{CC} = 15\text{V}$ (unless otherwise noted)

Parameter		Testing Conditions	Min	Typ	Max	Unit
Power Supply						
I_{Q+}	Quiescent Supply Current	$I_{NA} = I_{NB} = 3.3\text{V}$		70	150	μA
		$I_{NA} = I_{NB} = 5\text{V}$		70	150	
I_{Q-}		$I_{NA} = I_{NB} = 0\text{V}$		65	150	
V_{Clamp}	V_{CC} Zener Clamp Voltage	$I_{Q+} = 0.5\text{mA}$		22.8		V
Input Characteristics						
V_{IH}	Logic 1 Input Voltage		2.5			V
V_{IL}	Logic 0 Input Voltage				0.8	
I_{IN+}	Logic 1 Input Current	$I_N = 5\text{V}$		5	15	μA
I_{IN-}	Logic 0 Input Current	$I_N = 0\text{V}$	-30	-10		
Output Characteristics						
V_{OH}	High Output Voltage	$I_O = 1\text{mA}$	$V_{CC} - 0.025$			V
V_{OL-}	Low Output Voltage	$I_O = 1\text{mA}$			0.025	
R_{OH}	Output Resistance High State	$I_{OUT} = 100\text{mA}$		2.9		Ω
R_{OL}	Output Resistance Low State	$I_{OUT} = -100\text{mA}$		1.6		
Switching Time Characteristics						
t_{on}	Turn-on Propagation Delay	Refer to Figure 2 & Figure 3		45	65	ns
t_{off}	Turn-off Propagation Delay			45	65	
t_r	Output Rise Time			10	20	
t_f	Output Fall Time			8	20	

TYPICAL CHARACTERISTICS

At $V_{CC} = 15V$, $C_{LOAD} = 1000pF$, $T_A = 25^\circ C$ (unless otherwise noted)

V_{OL} vs Output Current

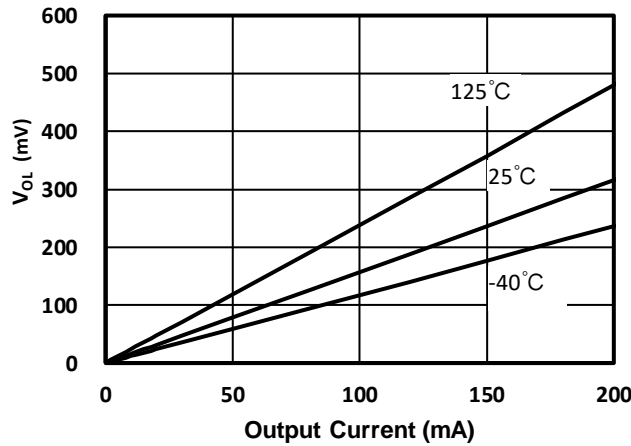

V_{OH} from Rail vs Output Current

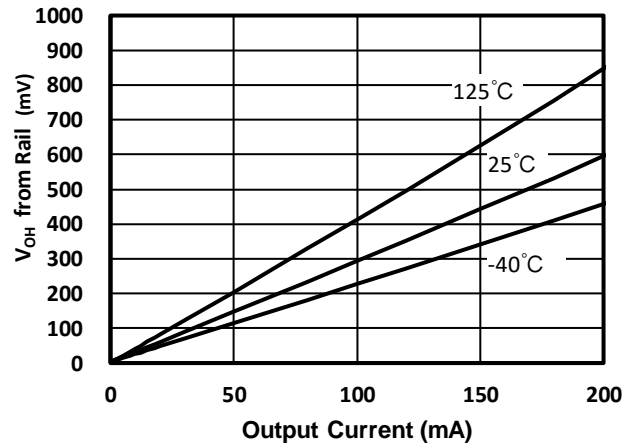

R_{OH} vs Supply Voltage

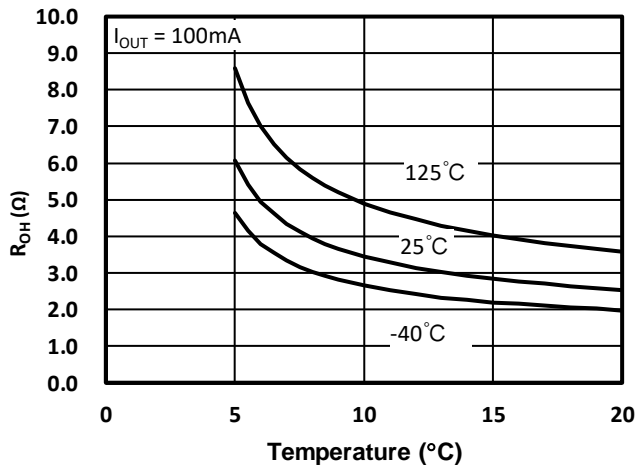

R_{OL} vs Supply Voltage

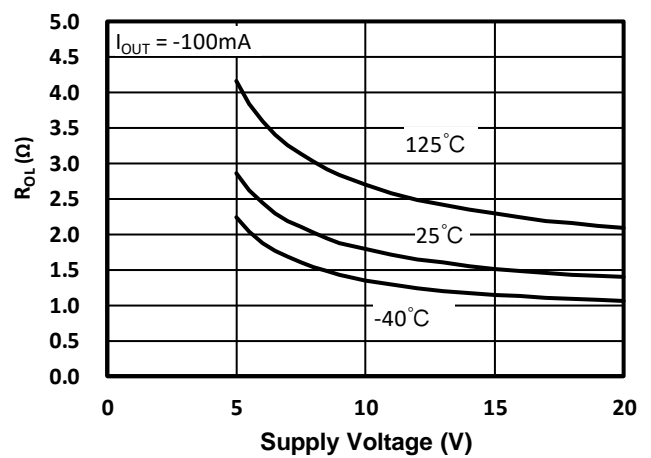

R_{OH} & V_{OL} vs Temperature

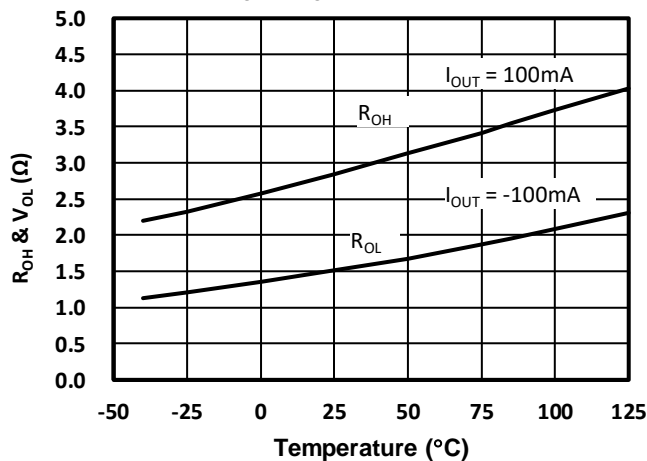

Input Current vs Temperature

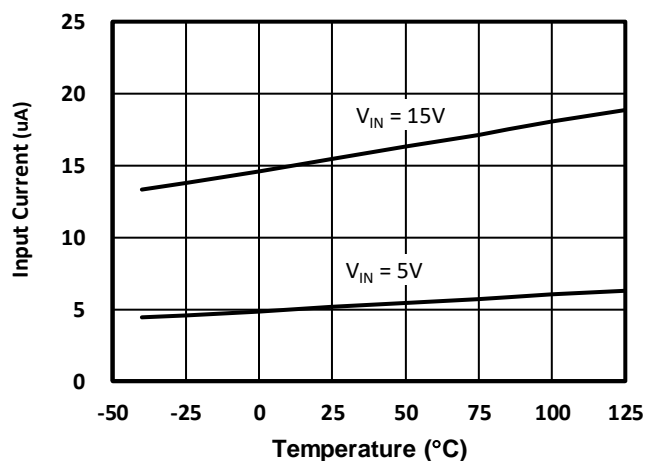

TYPICAL CHARACTERISTICS

At $V_{CC} = 15V$, $C_{LOAD} = 1000pF$, $T_A = 25^\circ C$ (unless otherwise noted)

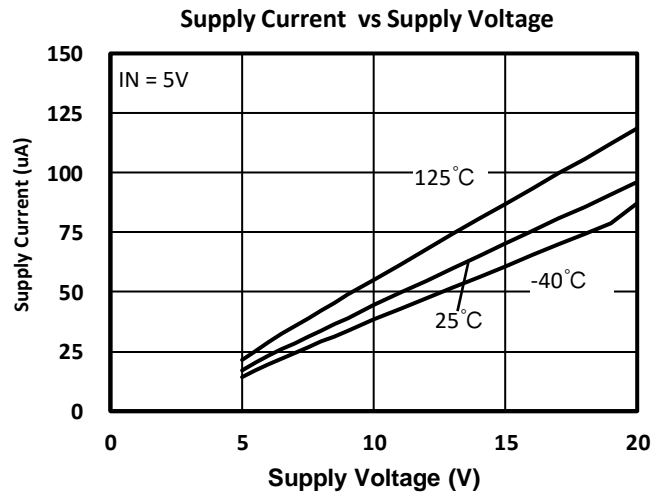
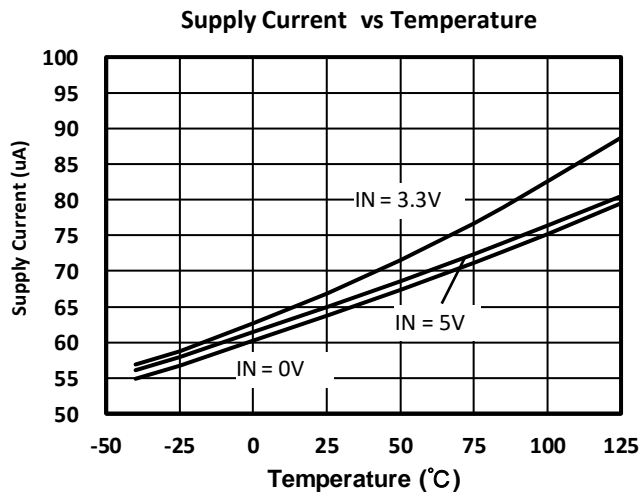
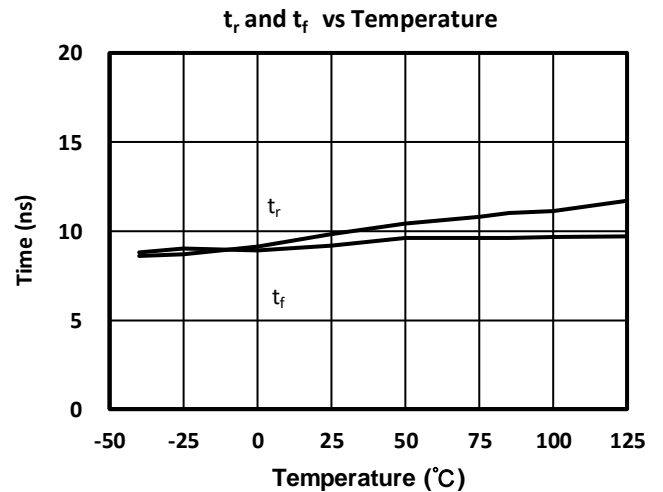
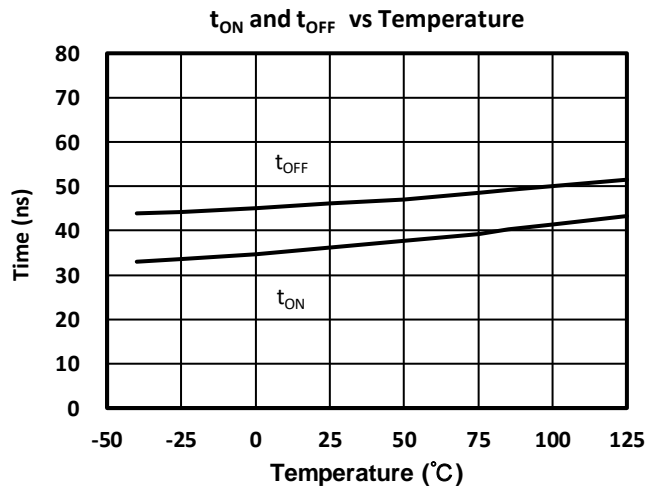
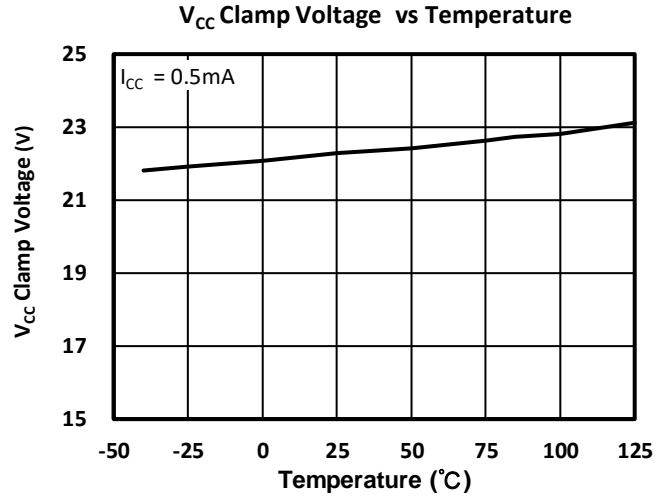
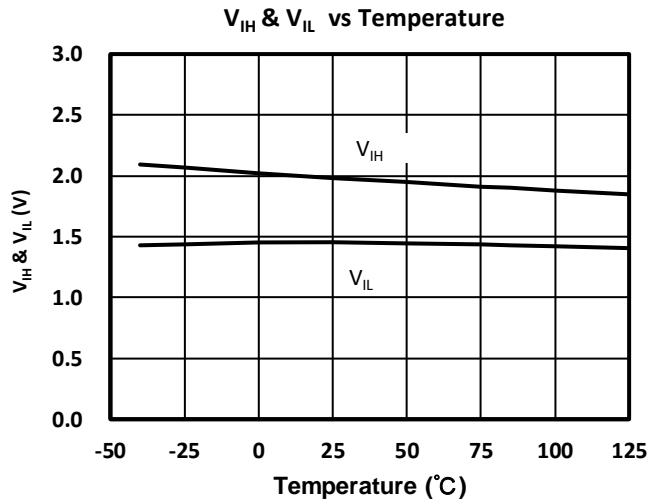

TYPICAL CHARACTERISTICS

At $V_{CC} = 15V$, $C_{LOAD} = 1000pF$, $T_A = 25^{\circ}C$ (unless otherwise noted)

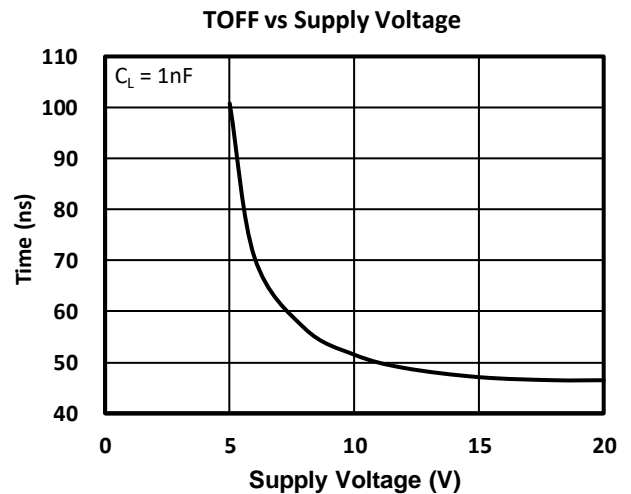
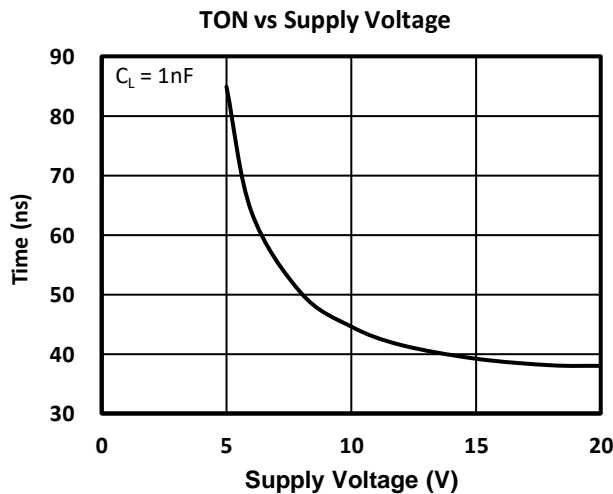
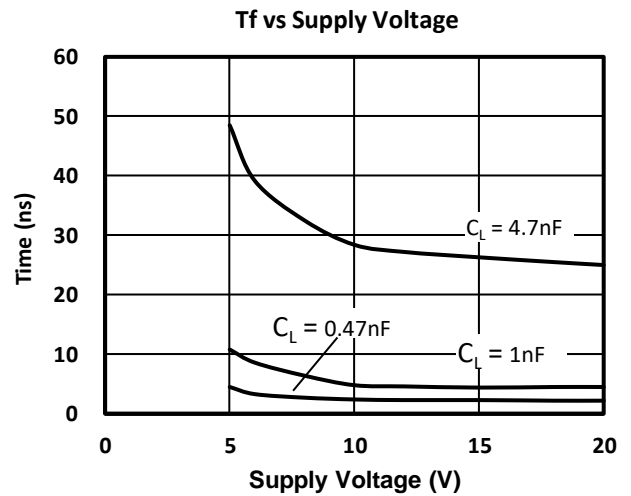
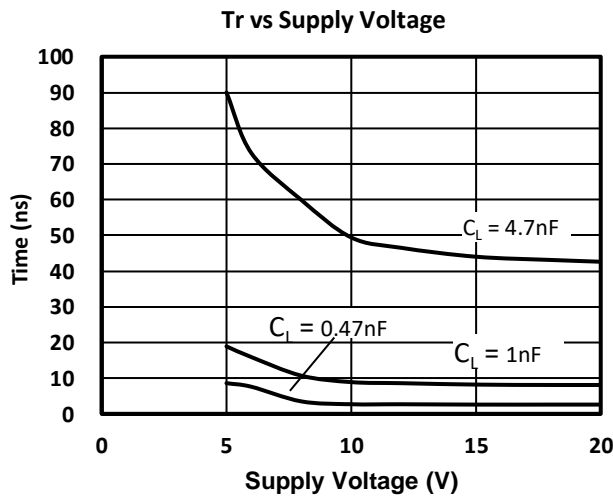
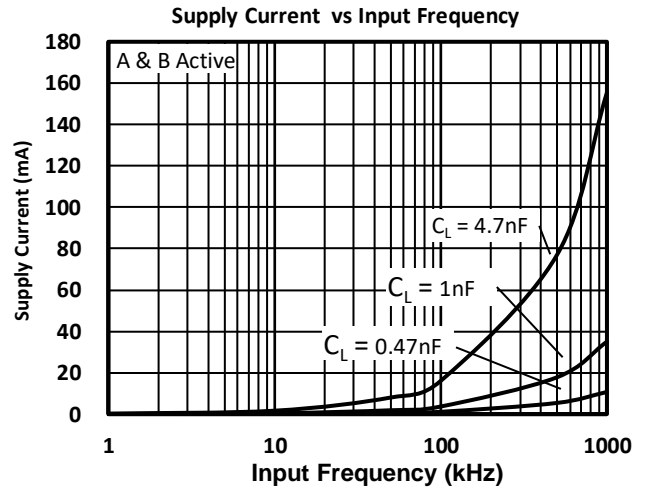
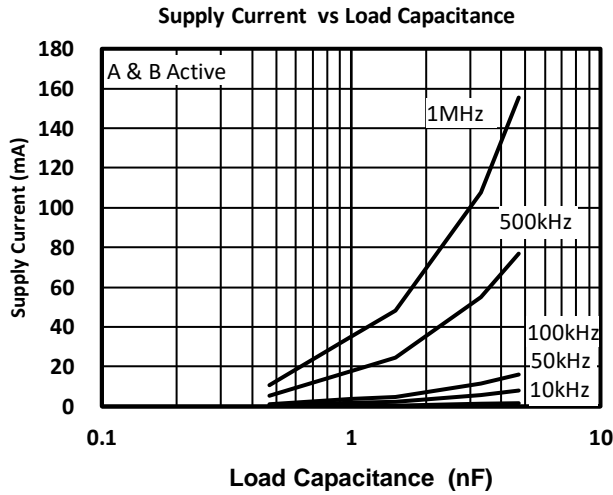

APPLICATION NOTES & ADDITIONAL DETAILS

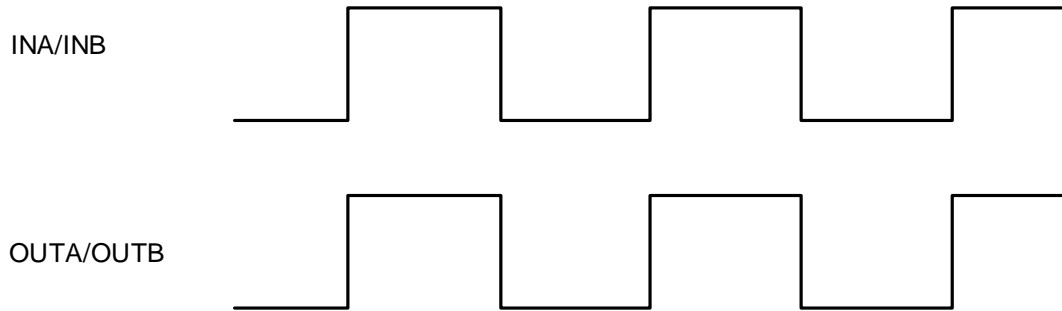

Figure 1. Input / Output Timing Diagram

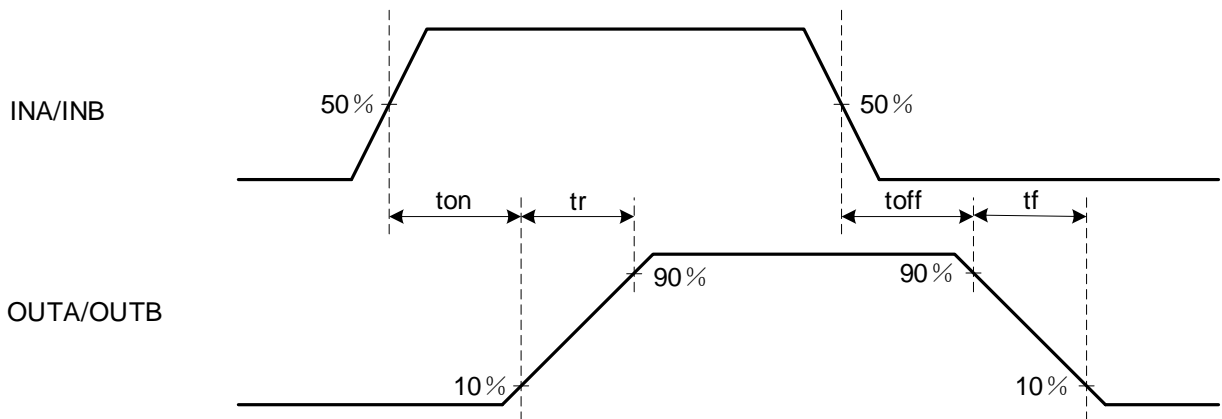

Figure 2. Switching Time Waveform Definitions

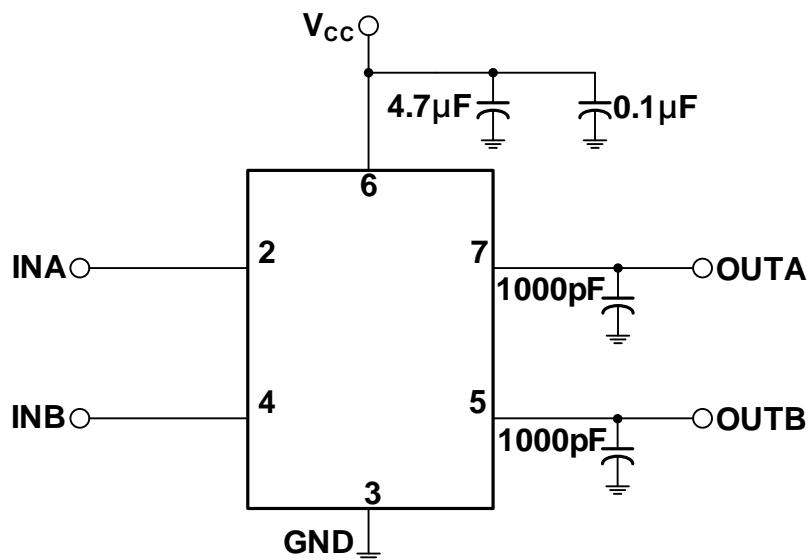
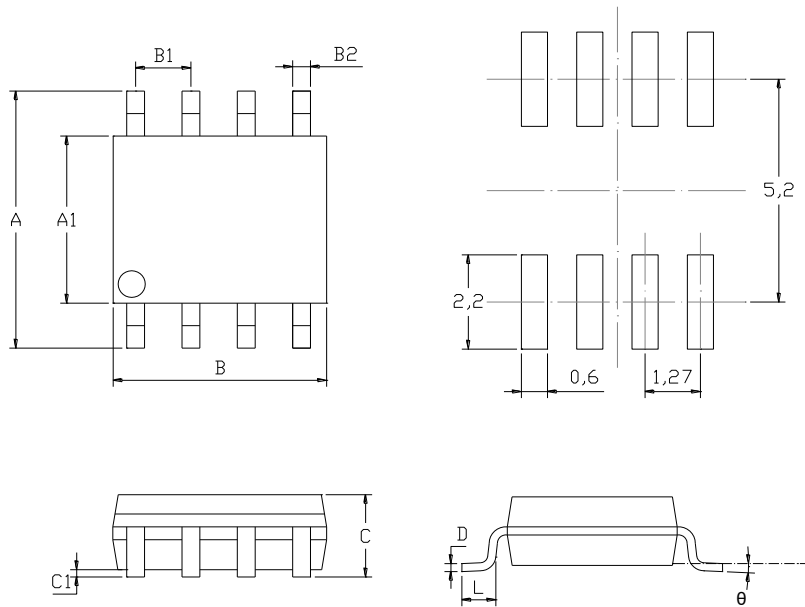

Figure 3. Test Circuit for Switching Time

MECHANICAL DIMENSIONS
SOP8 PACKAGE MECHANICAL DRAWING



SOP8 PACKAGE MECHANICAL DATA

symbol	dimensions			
	millimeters		inches	
	min	max	min	max
A	5.800	6.200	0.228	0.244
A1	3.800	4.000	0.150	0.157
B	4.700	5.100	0.185	0.201
B1	1.270		0.050	
B2	0.330	0.510	0.013	0.020
C		1.750		0.069
C1	0.100	0.250	0.004	0.010
L	0.400	1.270	0.016	0.050
D	0.170	0.250	0.007	0.010
θ	0°	8°	0°	8°

TAPE AND REEL INFORMATION

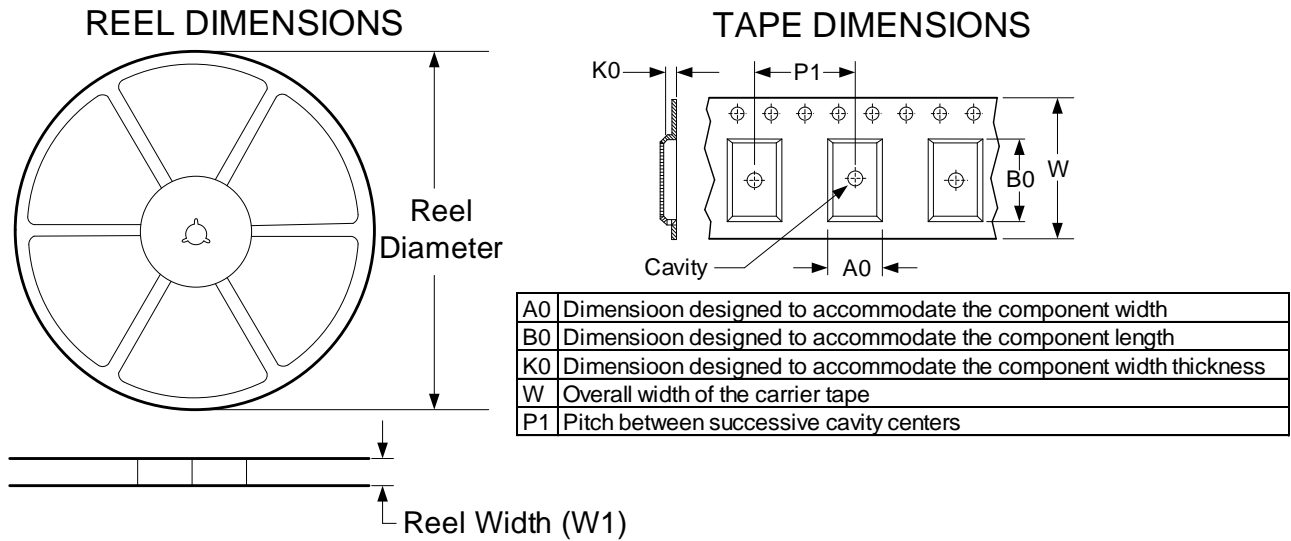

QUADRANT ASSIGNMENTS FOR PIN 1 ORIENTATION IN TAPE

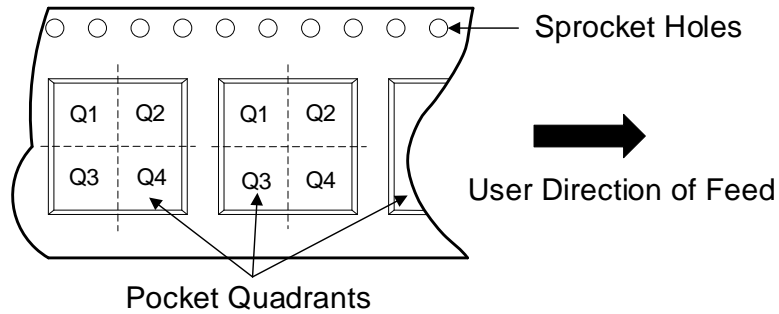

Device	Package Type	Pins	SPQ	Reel Diameter (mm)	Reel Width W1 (mm)	A0 (mm)	B0 (mm)	K0 (mm)	P1 (mm)	W (mm)	Pin1 Quadran
TS6348SOP8R	SOP8	8	2500	330.0	12.4	6.4	5.4	2.1	8.0	12.0	Q1

REVISION HISTORY

NOTE: Page numbers for previous revisions may be different from that of the current version.

2021/08/24— REV KY1.1.2A TO REV KY1.2.2B

Updated ABSOLUTE MAXIMUM RATINGS Vcc to Gnd Voltage.....	2
Updated RECOMMENDED OPERATING CONDITIONS Vcc to Gnd Voltage	2
Modify ABSOLUTE MAXIMUM RATINGS Input Voltage.....	1,2
Add ELECTRICAL CHARACTERISTICS I _{PEAK}	3

CONTACT INFORMATION

Trusignal Microelectronics

Phone: +86 512-65923982

Fax: +86 512-65923995

Email: support@trusignal.com; sales@trusignal.com